



CROCHET | SKILL LEVEL: EXPERIENCED

ABBREVIATIONS

Approx = Approximately

Beg = Begin(ning)(s)

Ch = Chain(s)

Cr2F = Skip next stitch.

1 trfp around next stitch.

Working in front of work,

1 trfp around skipped stitch.

Cr2B = Skip next stitch.

1 trfp around next stitch.

Working in back of work,

1 trfp around skipped stitch.

Cr3F = Skip next 2 stitches.

1 trfp around next stitch.

Working in front of work,

1 trfp around each of

skipped 2 stitches.

Cr3B = Skip next stitch.

1 trfp around each of next

2 stitches. *Working in back*

of work, 1 trfp around

skipped stitch.

Cr4F = Skip next 2 stitches.

1 trfp around each of next

2 stitches. *Working in front*

of work, 1 trfp around each

of skipped 2 stitches.

Cr4B = Skip next 2 stitches.

1 trfp around each of next

2 stitches. *Working in back*

of work, 1 trfp around each

of skipped 2 stitches.

Cr5F = Skip next 3 stitches.

1 trfp around each of next

2 stitches. *Working in front*

of work, 1 trfp around each

of skipped 3 stitches.

Cr5B = Skip next 2 stitches.

1 trfp around each of next

3 stitches. *Working in back*

of work, 1 trfp around each

of skipped 2 stitches.

Cr6F = Skip next 3 stitches.

1 trfp around each of next

3 stitches. *Working in front*

of work, 1 trfp around each

of skipped 3 stitches.

Cr6B = Skip next 3 stitches.

1 trfp around each of next

3 stitches. *Working in back*

of work, 1 trfp around each

of skipped 3 stitches.

Cont = Continue(ity)

Dcbp = Yoh and draw up

a loop around post of next

stitch at back of work,

inserting hook from right to

left. (Yoh and draw through

2 loops on hook) twice.

Dcfp = Yoh and draw up a

loop around post of next

stitch at front of work,

inserting hook from right to

left. (Yoh and draw through

2 loops on hook) twice.

Dcfp2tog = (Yoh and draw

up a loop around post of

next stitch at front of work,

inserting hook from right to

left. Yoh and draw through

2 loops on hook) twice. Yoh

and draw through all loops

on hook.

Hdc = Half double crochet

Hdc2tog = Yoh and draw

up a loop in each of next

2 stitches. Yoh and draw

through all loops on hook.

Inc = Increase(s)

Pat = Pattern

PM = Place marker

Rep = Repeat

Rnd(s) = Round(s)

RS = Right side

Sl st = Slip stitch

Sp(s) = Space(s)

St(s) = Stitch(es)

Trfp = (Yoh) twice and draw

up a loop around post of

next stitch at front of work,

inserting hook from right to

left. (Yoh and draw through

2 loops on hook) 3 times.

WS = Wrong side

Yoh = Yarn over hook

MATERIALS

Caron® Simply Soft™ (6 oz/170.1 g; 315 yds/288 m)

Sizes XS/S M L XL 2/3XL 4/5XL

Fuchsia (39764) 7 8 9 9 10 11 balls

Size U.S. H/8 (5 mm) crochet hook or size needed to obtain gauge.
Stitch markers.

SIZES

To fit bust measurement

XS/S	28-34" [71-86.5 cm]
M	36-38" [91.5-96.5 cm]
L	40-42" [101.5-106.5 cm]
XL	44-46" [112-117 cm]
2/3XL	48-54" [122-137 cm]
4/5XL	56-62" [142-157.5 cm]

Finished bust

XS/S	42" [106.5 cm]
M	45½" [115.5 cm]
L	49" [124.5 cm]
XL	53" [134.5 cm]
2/3XL	57" [144.5 cm]
4/5XL	62" [157.5 cm]

GAUGE

13 hdc and 10 rows = 4" [10 cm].

INSTRUCTIONS

The instructions are written for smallest size. If changes are necessary for larger size(s) the instructions will be written thus (.). Numbers for each size are shown in the same color throughout the pattern. When only one number is given in black, it applies to all sizes.

Cable Panel (worked over 20 sts)

See Chart on page 5.

Note: Ch-1 sp does not count as st. See diagram on page 5.

1st row: (RS). 1 hdc in next hdc. 1 dcfp around each of next 3 sts. Cr6B. Ch 1. Cr6F. 1 dcfp around each of next 3 sts. 1 hdc in next hdc.

2nd row: (WS). 1 hdc in next hdc. 1 dcbb around each of next 6 sts. 1 hdc in each of next 3 sts. Ch 1. 1 hdc in each of next 3 sts. 1 dcbb around each of next 6 sts. 1 hdc in next hdc.

3rd row: 1 hdc in next hdc. Cr6B. 1 dcfp around each of next 3 sts. Ch 1. 1 dcfp around each of next 3 sts. Cr6F. 1 hdc in next hdc.

4th row: 1 hdc in next hdc. 1 dcbb around each of next 9 sts. Ch 1. 1 dcbb around each of next 9 sts. 1 hdc in next hdc.

5th to 8th rows: Rep 1st to 4th rows once more.

9th row: 2 hdc in next hdc. 1 dcfp around next st. Dcfp2tog. Cr6B. Ch 1. Cr6F. Dcfp2tog. 1 dcfp around next st. 2 hdc in next hdc.

10th row: 1 hdc in each of next 2 hdc. 1 dcbb around each of next 5 sts. 1 hdc in each of next 3 sts. Ch 1. 1 hdc in each of next 3 sts. 1 dcbb around each of next 5 sts. 1 hdc in each of next 2 hdc.

11th row: 1 hdc in each of next 2 hdc. Cr5B. 1 dcfp around each of next 3 sts. Ch 1. 1 dcfp around each of next 3 sts. Cr5F. 1 hdc in each of next 2 hdc.

12th row: 1 hdc in each of next 2 hdc. 1 dcbb around each of next 8 sts. Ch 1. 1 dcbb around each of next 8 sts. 1 hdc in each of next 2 hdc.

13th row: 1 hdc in next hdc. 2 hdc in next hdc. 1 dcfp around next st. Dcfp2tog. Cr5B. Ch 1. Cr5F. Dcfp2tog. 1 dcfp around next st. 2 hdc in next hdc. 1 hdc in next hdc.

14th row: 1 hdc in each of next 3 hdc. 1 dcbb around each of next 5 sts. 1 hdc in each of next 2 sts. Ch 1. 1 hdc in each of next 2 sts. 1 dcbb around each of next 5 sts. 1 hdc in each of next 3 hdc.

15th row: 1 hdc in each of next 3 hdc. Cr5B. 1 dcfp around each of next 2 sts. Ch 1. 1 dcfp around each of next 2 sts. Cr5F. 1 hdc in each of next 3 hdc.

16th row: 1 hdc in each of next 3 hdc. 1 dcbb around each of next 7 sts. Ch 1. 1 dcbb around each of next 7 sts. 1 hdc in each of next 3 hdc.

17th row: 1 hdc in each of next 2 hdc. 2 hdc in next hdc. 1 dcfp around next st. Dcfp2tog. Cr4B. Ch 1. Cr4F. Dcfp2tog. 1 dcfp around next st. 2 hdc in next hdc. 1 hdc in each of next 2 hdc.

18th row: 1 hdc in each of next 4 hdc. 1 dcbb around each of next 4 sts. 1 hdc in each of next 2 sts. Ch 1. 1 hdc in each of next 2 sts. 1 dcbb around each of next 4 sts. 1 hdc in each of next 4 hdc.

19th row: 1 hdc in each of next 4 hdc. Cr4B. 1 dcfp around each of next 2 sts. Ch 1. 1 dcfp around each of next 2 sts. Cr4F. 1 hdc in each of next 4 hdc.

20th row: 1 hdc in each of next 4 hdc. 1 dcbb around each of next 6 sts. Ch 1. 1 dcbb around each of next 6 sts. 1 hdc in each of next 4 hdc.

21st row: 1 hdc in each of next 3 hdc. 2 hdc in next hdc. Dcfp2tog. Cr4B. Ch 1. Cr4F. Dcfp2tog. 2 hdc in next hdc. 1 hdc in each of next 3 hdc.

22nd row: 1 hdc in each of next 5 hdc. 1 dcbp around each of next 3 hdc. 1 hdc in each of next 2 hdc. Ch 1. 1 hdc in each of next 2 hdc. 1 dcbp around each of next 3 hdc. 1 hdc in each of next 5 hdc.

23rd row: 1 hdc in each of next 5 hdc. Cr3B. 1 dcfp around each of next 2 sts. Ch 1. 1 dcfp around each of next 2 sts. Cr3F. 1 hdc in each of next 5 hdc.

24th row: 1 hdc in each of next 5 hdc. 1 dcbp around each of next 5 sts. Ch 1. 1 dcbp around each of next 5 sts. 1 hdc in each of next 5 hdc.

25th row: 1 hdc in each of next 4 hdc. 2 hdc in next hdc. Dcfp2tog. Cr3B. Ch 1. Cr3F. Dcfp2tog. 2 hdc in next hdc. 1 hdc in each of next 4 hdc.

26th row: 1 hdc in each of next 6 hdc. 1 dcbp around each of next 3 sts. 1 hdc in next st. Ch 1. 1 hdc in next st. 1 dcbp around each of next 3 sts. 1 hdc in each of next 6 hdc.

27th row: 1 hdc in each of next 6 hdc. Cr3B. 1 dcfp around next st. Ch 1. 1 dcfp around next st. Cr3F. 1 hdc in each of next 6 hdc.

28th row: 1 hdc in each of next 6 hdc. 1 dcbp around each of next 4 sts. Ch 1. 1 dcbp around each of next 4 sts. 1 hdc in each of next 6 hdc.

29th row: 1 hdc in each of next 5 hdc. 2 hdc in next hdc. Skip next st. Cr3B. Ch 1. Cr3F. Skip next st. 2 hdc in next hdc. 1 hdc in each of next 5 hdc.

30th row: 1 hdc in each of next 7 hdc. 1 dcbp around each of next 2 sts. 1 hdc in next st. Ch 1. 1 hdc in next st. 1 dcbp around each of next 2 sts. 1 hdc in each of next 7 hdc.

31st row: 1 hdc in each of next 6 hdc. 2 hdc in next hdc. Skip next st. Cr2B. Ch 1. Cr2F. Skip next st. 2 hdc in next hdc. 1 hdc in each of next 6 hdc.

BODY

Notes: Join all rnds with sl st to first st. **Turn** at end of each rnd. Sweater is worked top down. Ch 2 at beg of rnd **does not** count as st.

Beg at neck edge, ch 80. Join with sl st to first ch to form a ring, taking care not to twist chain. PM for beg of rnd.

1st rnd: (RS). Ch 2. 1 hdc in back bump of each ch around. Join. **Turn.** 80 hdc.

2nd rnd: (WS). Ch 2. 1 hdc in first st. 1 dcbp. *1 hdc in next st. 1 dcbp. Rep from * around. Join. **Turn.**

3rd rnd: Ch 2. *1 dcfp. 1 hdc in next st. Rep from * around. Join. **Turn.**

4th rnd: Ch 2. *2 hdc in next st. 1 hdc in each of next 19 sts. Rep from * around. Join. 84 hdc.

Proceed in Cable Panel as follows:

1st rnd: (RS). Ch 2. *2 hdc in next hdc. Work 1st row of Cable Panel across next 20 hdc. Rep from * around. Join. **Turn.** 88 sts.

2nd rnd: (WS). Ch 2. *Work 2nd row of Cable Panel. 2 hdc in each of next 2 hdc. Rep from * around. Join. **Turn.** 96 sts.

3rd rnd: Ch 2. *2 hdc in next hdc. 1 hdc in each of next 2 hdc. 2 hdc in next hdc. Work 3rd row of Cable Panel. Rep from * around. Join. **Turn.** 104 sts.

4th rnd: Ch 2. *Work 4th row of Cable Panel. 2 hdc in next hdc. 1 hdc in each of next 4 hdc. 2 hdc in next hdc. Rep from * around. Join. **Turn.** 112 sts.

5th rnd: Ch 2. *2 hdc in next hdc. 1 hdc in each of next 6 hdc. 2 hdc in next hdc. Work 5th row of Cable Panel. Rep from * around. Join. **Turn.** 120 sts.

6th rnd: Ch 2. *Work 6th row of Cable Panel. 2 hdc in next hdc. 1 hdc in each of next 8 hdc. 2 hdc in next hdc. Rep from * around. Join. **Turn.** 128 sts.

7th rnd: Ch 2. *2 hdc in next hdc. 1 hdc in each of next 10 hdc. 2 hdc in next hdc. Work 7th row of Cable Panel. Rep from * around. Join. **Turn.** 136 sts.

Cable Panel is now in position.

Cont in same manner, inc 8 sts (as before) on every rnd until there are **184** (**200-216-248-232-312**) sts.

Sizes XS/S, M, L, XL and 2/3XL

only: Next rnd: (WS). Ch 2. *Work appropriate row of Cable Panel. 1 hdc in each hdc to next Cable Panel. Rep from * around. Join. **Turn.**

Next rnd: Ch 2. *2 hdc in next hdc. 1 hdc in each hdc to last hdc before Cable Panel. 2 hdc in next hdc. Work appropriate row of Cable Panel. Rep from * around. Join. **Turn.**

Rep last 2 rnds **3 (3-3-1-4)** time(s) more. **216 (232-248-264-288)** sts.

All sizes: Cont even until all 31 rows of Cable Panel pat have been completed. Join. Turn.

Next rnd: (WS). Ch 1. 1 sc in each st around. Fasten off.

Divide for Body and Sleeves:

With RS facing, skip first **37 (40-43-45-52-58)** sc. Join yarn with sl st to next sc.

Proceed as follows:

1st rnd: (RS - dividing rnd). Ch 2. 1 hdc in each of first **68 (74-80-88-92-98)** sc for Front. Ch 2. Skip next **40 (42-44-46-52-56)** sc for Left Sleeve. 1 hdc in each of next **68 (74-80-88-92-98)** sc for Back. Ch 2. Skip last **40 (42-44-46-52-56)** sc for Right Sleeve. Join. **Turn.** PM between last 2 ch for beg of rnd.

2nd rnd: (WS). Sl st in each of first 2 ch. Ch 2. 1 hdc in same sp as last sl st. 1 hdc in each hdc, working 2 hdc in next ch-2 sp. 1 hdc in last ch. Join. **Turn. 140 (152-164-180-188-202)** hdc for Body.

3rd rnd: Ch 2. 1 hdc in each hdc around. Join. **Turn.**

Rep last rnd until work from dividing rnd measures **9 (10-11-11-14-15)" [23 (25.5-28-28-35.5-38) cm]**, ending on a WS rnd.

Ribbing: Next rnd: (RS). Ch 2. *1 dcfp around next hdc. 1 hdc in next hdc. Rep from * around. Join with sl st to first st. **Turn.**

Next rnd: (WS). Ch 2. *1 hdc in next hdc. 1 dcgp around next st. Rep from * around. Join with sl st to first st. Rep last 2 rnds twice more. Fasten off.

SLEEVES

With RS facing, join yarn with sl st to 2nd ch at underarm.

1st rnd: (RS). Ch 2. 1 hdc in same sp as sl st. 1 hdc in each of next **40 (42-44-46-52-56)** sc for Sleeve. 1 hdc in last ch. Join. **42 (44-46-48-54-58)** hdc. PM for beg of rnd. **Turn.**

Turning at end of each rnd, proceed as follows:

Next 6 (6-5-5-3-3) rnds: 1 hdc in each hdc around. Join. **Turn.**

Next rnd: Hdc2tog. 1 hdc in each hdc to last 2 hdc. Hdc2tog. Join. **Turn.**

Rep last **7 (7-6-6-4-4)** rnds **4 (4-4-5-6-7)** times more. **32 (34-36-36-40-42)** sts.

Next rnd: 1 hdc in each st around. Join. **Turn.**

Rep last rnd until work from dividing rnd measures 13" [33 cm], ending on a WS rnd.

Ribbing: Next rnd: (RS). Ch 2. *1 dcfp around next hdc. 1 hdc in next hdc. Rep from * around. Join with sl st to first st.

Next rnd: (WS). Ch 2. *1 hdc in next hdc. 1 dcgp around next st. Rep from * around. Join with sl st to first st. Rep last 2 rnds twice more. Fasten off.





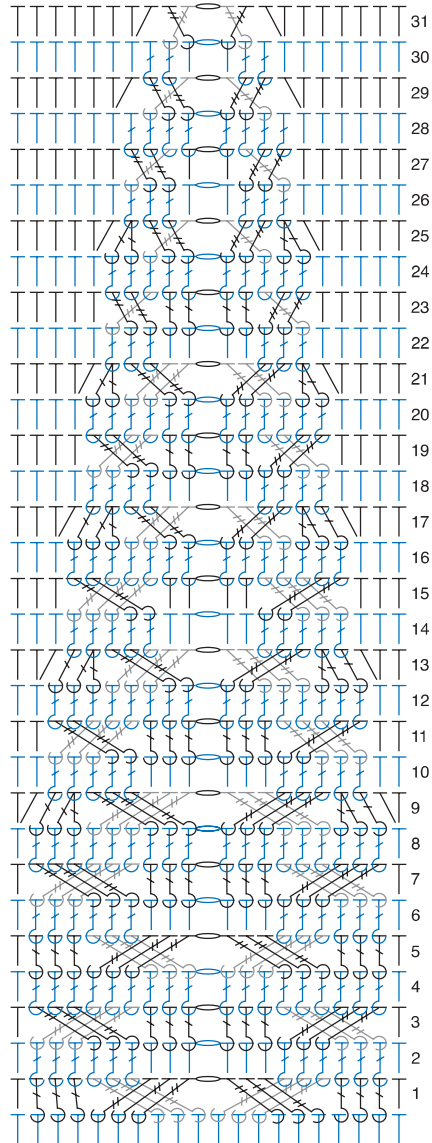

FINISHING

Pin all pieces to measurements. Cover with a damp cloth leaving cloth to dry. Sew underarm seams.



CABLE PANEL

STITCH KEY

-  = chain (ch)
-  = half double crochet (hdc)
-  = back post double
crochet (dcbp)
-  = front post double
crochet (dcfp)
-  = front post treble
crochet (trfp)
-  = front post double crochet
2 together (dcfp2tog)

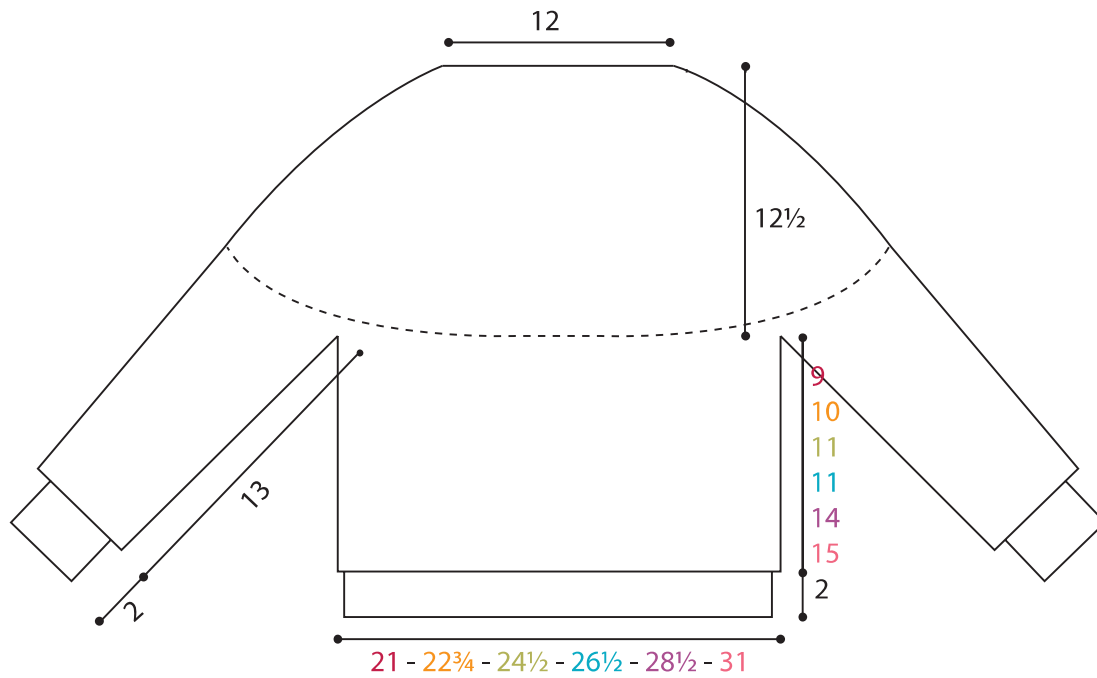

FRONT



BACK

